



DATOS MOTOR

POTENCIA	2HP
REVOLUCIONES	1760
FRECUENCIA	60HZ
TORQUE MOTOR NOMINAL	8,3
CARCASA (PAM)	90(B5)
TIPO BRIDA	FF-165
EFICIENCIA MOTOR	IE 2

DATOS REDUCTOR

REFERENCIA	550006
TIPO	ORTOGONAL
MODELO	FCN
MATERIAL	ALUMINIO
CARCASA	90
RELACION DE TRANSMISION i:	20
VELOCIDAD SALIDA	88,00
TORQUE MAXIMO	360
TORQUE OPERACIÓN	139
FACTOR DE SERVICIO	2,6

PLANOS REDUCTOR

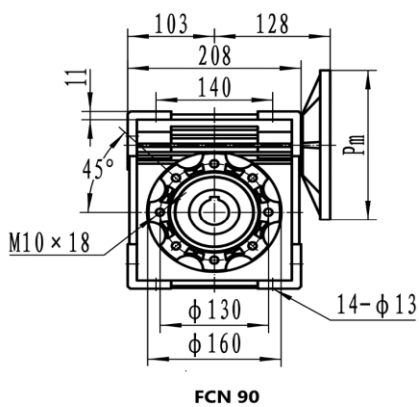

Input shaft hole

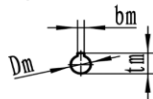

Output shaft hole

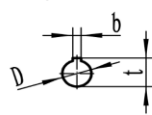

Dimensions of Output Shaft			
D H7	b	D10	t
35	10	38.3	

	Pm	Dm	bm	tm
80B5	200	19	6	21.8
80B14	120			
90B5	200	24	8	27.3
90B14	140			
100/112B5	250	28	8	31.3
100/112B14	160			

